

STUDIOLUX

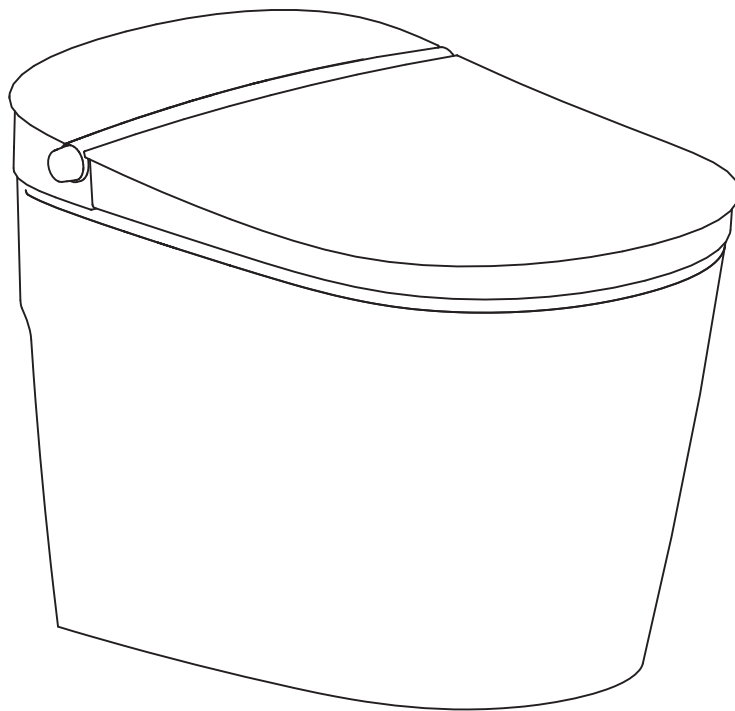
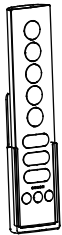

MODEL: SLi2000

Installation instructions and manuals

Installation instructions for skilled technicians!

After installation, please hand over the installation instructions to the user.

IMPORTANT SAFEGUARDS

READ ALL INSTRUCTION BEFORE USING

When using the electronic product, especially in the presence of children, basic safety precautions should always be followed, including the following. Please read all instructions before use.



DANGER—Reduce the risk of electric shock

1. Do not use while bathing.
2. Do not place or store the product where it may fall or be dragged into a bathtub or sink.
3. Do not place in or drop into water or other liquid.
4. Do not touch the product if it falls into the water, and unplug the power supply immediately.



WARNING—Reduce the risk of burns, electric shock, fire or personal injury

1. Please keep a close watch when children or disabled persons are using or near the products in use.
2. This product is used only for the intended purpose described in this manual. Do not use accessories not recommended by the manufacturer.
3. Never operate this product if it has a damaged cord or plug or if it is not working properly, if it has been dropped or damaged, or dropped into water. Return the product to a service center for examination and repair.
4. Keep the power cord away from the heating surface.
5. Do not clog the vents of the product, or place the product on a soft surface, such as a bed or sofa, where the vents may be blocked. Keep the air unblocked and no cotton wool or hair, etc. in the pores.
6. Don't use products while sleeping or drowsy.
7. Do not put or insert any object into any opening or hose.
8. Do not use outdoors or operate where aerosol (spray) products are being used or when oxidated products are being administered.
9. Unplug this product before filling. Fill (reservoir) with water. Do not overfill (or specify filling instructions).
10. Do not clean the product and power plug with water, it might cause electric shock or damage.
11. Do not disassemble, repair or modify the product, otherwise it might cause fire.
12. Do not stand or put heavy things on the seat, it might cause product damage.
13. Do not throw burning items like cigarette butts into the product, it might cause fire.
14. Do not open or close the cover or seat forcibly, and do not lean on the cover when the product in use, it might cause product damage.
15. Connect this product to a properly grounded outlet only. See Grounding Instructions.
16. THIS PRODUCT MUST BE PLUGGED into a regular voltage Grounded GFCI outlet (North America 120V AC, 60Hz). The rated power consumption is 1000W.
17. Do not use extension cord. If you are not sure if the equipment is properly grounded, consult a licensed electrician.

ISED Warning statements in User Manual

This device contains licence–exempt transmitter(s)/receiver(s) that comply with Innovation, Science and Economic Development Canada’s licence–exempt RSS(s). Operation is subject to the following two conditions:

1. This device may not cause interference.
2. This device must accept any interference, including interference that may cause undesired operation of the device.

L’ émetteur/récepteur exempt de licence contenu dans le présent appareil est conforme aux CNR d’ Innovation, Sciences et Développement économique Canada applicables aux appareils radio exempts de licence. L’ exploitation est autorisée aux deux conditions suivantes :

1. L’ appareil ne doit pas produire de brouillage;
2. L’ appareil doit accepter tout brouillage radioélectrique subi, même si le brouillage est susceptible d’ en compromettre le fonctionnement.

FCC Warning statements in User Manual

This device complies with Part 15 of the FCC Rules. Operation is subject to the following two conditions: (1) this device may not cause harmful interference, and (2) this device must accept any interference received, including interference that may cause undesired operation.

Caution: The user is cautioned that changes or modifications not expressly approved by the party responsible for compliance could void the user's authority to operate the equipment.

Note: This equipment has been tested and found to comply with the limits for a Class B digital device, pursuant to part 15 of the FCC Rules. These limits are designed to provide reasonable protection against harmful interference in a residential installation. This equipment generates uses and can radiate radio frequency energy and, if not installed and used in accordance with the instructions, may cause harmful interference to radio communications. However, there is no guarantee that interference will not occur in a particular installation. If this equipment does cause harmful interference to radio or television reception, which can be determined by turning the equipment off and on, the user is encouraged to try to correct the interference by one or more of the following measures:

- Reorient or relocate the receiving antenna.
- Increase the separation between the equipment and receiver.
- Connect the equipment into an outlet on a circuit different from that to which the receiver is connected.
- Consult the dealer or an experienced radio/TV technician for help.

FCC Supplier’s Declaration of Conformity

Product name: Bathroom remote control

Model number: 13D401–2004X

Suppliers Name: WUXI DENVEL INTELLIGENT ELECTRONIC INC.

Suppliers Address: Building A, No.8 LianHe Road, WuXi, JiangSu, China

Suppliers Website: www..denvel.com

Suggestions on power line and water supply connection

Technical drawings and power cord connections suggest

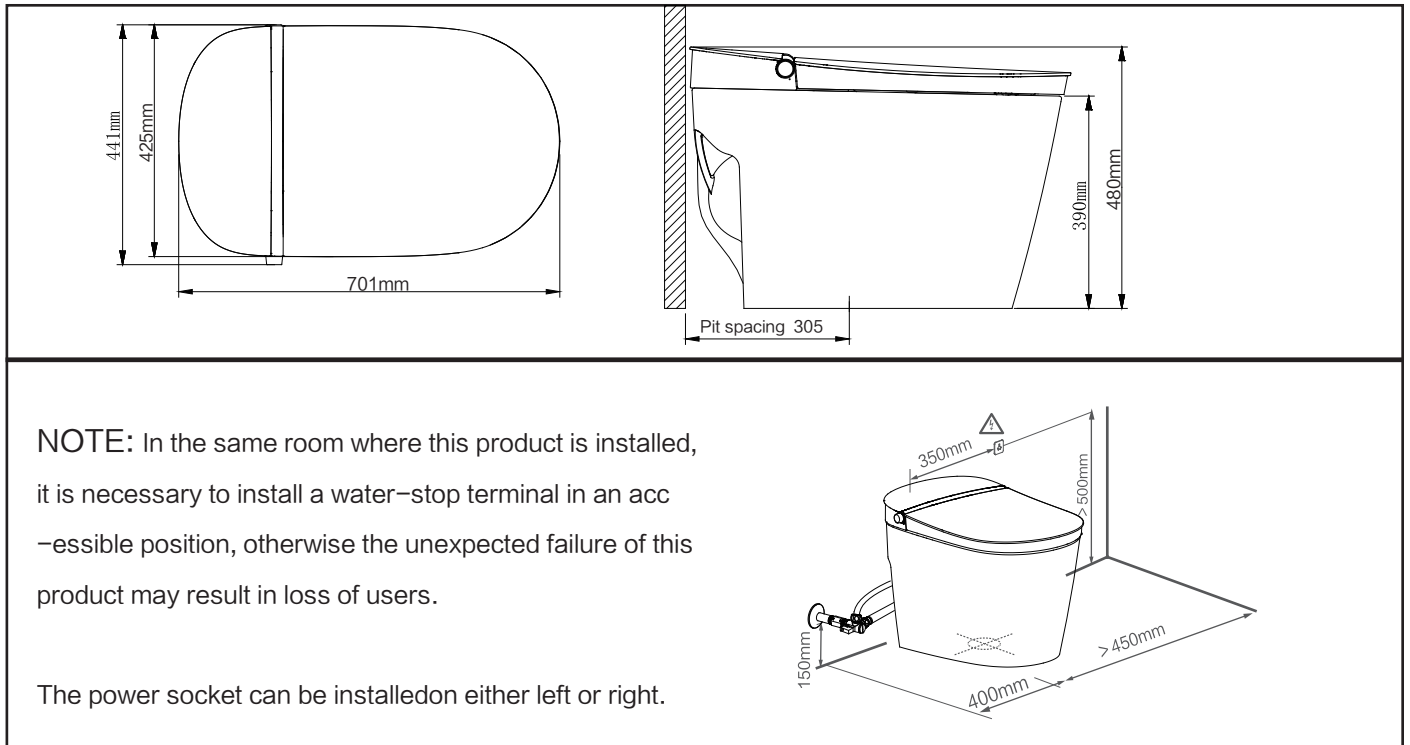

*This product is suitable for AC120V/60HZ power supply. In order to ensure safe use, the socket and its connecting wires must be able to withstand more than 15A current.

Grounding instructions

This product should be grounded. In the case of an electrical short circuit, grounding reduces the risk of electric shock by providing an escape path for the current. This product is equipped with a power cord with a ground wire and a properly grounded plug. The plug must be plugged into a properly installed and grounded socket.

★★★ DANGER: Improper use of the grounding plug may result in electric shock

If the power cord or plug needs to be repaired or replaced, do not connect the ground wire to any of the flat pins. The conductor with green stripe or without yellow stripe on the outer insulation surface is grounding wire.

If you do not fully understand the grounding instructions or if you have questions about whether the product is properly grounded, please consult a qualified electrician or maintenance personnel.

This product is for use on a normal 120 V circuit, and has a grounding plug that looks like the plug illustrated in sketch A .in Figure 1. A temporary adapter, which looks like the adapter illustrated in sketches B and C, may be used to connect this plug to a 2–pole receptacle as shown in sketch B. if a properly grounded outlet is not available. The temporary adapter should be plugged into a properly grounded outlet (sketch A) and should be installed by a licensed electrician. The green colored rigid tab extending from the adapter must be connected to a permanent ground such as a properly grounded outlet box cover. Whenever the adapter is used, it must be held in place by the screw.

The product is factory–equipped with a specific power cord and plug that allow connection to the appropriate circuit. Make sure the product is connected to the same socket as the plug configuration. This product should not use adapters. Do not modify the supplied plug, if it is not suitable for the socket, please install the appropriate socket by a qualified electrician. If the product must be reconnected using different types of circuits, it should be reconnected by qualified maintenance personnel.

If an extension cord is required, only use a 3–core extension cord with a 3–core grounding plug and a 3–slot socket that accepts the plug on the product. The damaged wires must be replaced or repaired.

Preferred Connection

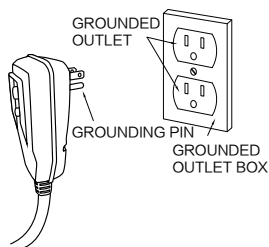



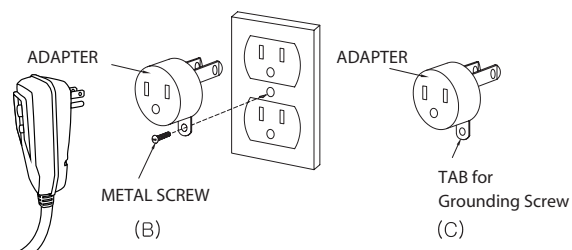

Temporary Connection



Precautions before use

In order to avoid personal injury and property damage to users and other people, please read the following safety precautions carefully and strictly observe them. After reading, please keep this manual in an a drawer were you can access easily.

 <p>PROHIBITED</p>	<ul style="list-style-type: none"> ☆ Do not touch the power plug with wet hand, otherwise it may cause electric shock. ☆ It is strictly forbidden to put the electrified product on its side or upside-down, otherwise it may cause fire or burn down. ☆ It is strictly forbidden to disassemble, repair or transform the product by yourself, otherwise it may cause fire or electric shock. ☆ It is strictly forbidden to put lighted cigarettes and other combustibles into the toilet cover, otherwise it may cause fire. ☆ It is strictly forbidden to use this product when the seat and upper cover are not fully opened or closed. ☆ It is strictly forbidden to use power extension cord or loose and unstable power socket, otherwise it may cause fire or electric shock. ☆ It is strictly forbidden to put fingers or other objects into the warm air outlet, otherwise it may cause scalding, electric shock or burn. ☆ It is strictly forbidden to pour water, detergent, urine or other liquid on and around the surface, or power plug, otherwise it may cause fire or electric shock.
 <p>NOTICE</p>	<ul style="list-style-type: none"> ☆ When thundering, please pull out the power plug. ☆ Do not operate products that have fallen into the water or soaked in water, and immediately unplug the power plug. ☆ The socket should be installed in the place where it is not easy to get wet. It is recommended to use waterproof socket. It is recommended to place the plug on the wall. Please refer to the technical drawings and suggestions on power line and water supply connection. ☆ Please do not connect the inlet water line with the outlet water line of the water heater. The inlet water temperature should be 3°C – 35°C. ☆ Do not let the sunlight directly irradiate the product, in order to avoid the product discoloration or the burn due to the temperature instability. ☆ Do not use industrial water, waste water, sea water, reclaimed water and other water sources, otherwise it may cause skin inflammation and other diseases. ☆ This product is for household use only. ☆ The product must be connected to a separate circuit. No other electrical product shares the circuit with this product. Sharing a circuit can cause a fuse to blow out or a circuit breaker to trip. Continuous use in such cases may result in fire or property damage.

 NOTICE	<ul style="list-style-type: none"> ☆ Do not use banana oil, gasoline, liquid medicine and detergent, insecticide and hard brush to clean this product. Toilet cleaner may only be used for ceramic body. ☆ Do not use this product in rooms with humidity more than 90% RH, the use environment should have a dry and wet separation, such as installing shower room or shower curtain. ☆ For the newly decorated house, the residual mud and sand in the pipeline are easy to damage the machine and affect human health. Please remove the sewage from the pipeline before installation. ☆ Do not stand on the seat, toilet cover, do not place heavy objects, and do not press or lean on the toilet cover, so as not to damage the product. ☆ Please set the temperature of water and seat on 'low' when the old, weak, sick and disabled or children use the product, and touch the sensor when you sit on the seat properly. ☆ Pull out the power plug before cleaning, do not web the product directly. ☆ in cold winter, if do not use the product for a long time, please discharge the tank water following the instructions. Or it might cause product damage. ☆ This appliance is provided with a protective device that may make the appliance inoperable under some abnormal conditions (such as immersion of the appliance). If the appliance becomes inoperable, contact the STUDIOLUX service team.
 MUST ABIDE BY	<ul style="list-style-type: none"> ☆ Do not let children play with this product. ☆ Do not supply water or power to the product before installation completed. ☆ If it is not used for a long time, please unplug the plug and empty the water in the product. ☆ When installing, disassembling, repairing and maintaining the product, the power plug must be pulled off and the water supply valve must be closed. ☆ This product uses AC 120V/ 60Hz power supply; in order to ensure safe use, the socket and its connecting wires must be able to withstand more than 15A current. ☆ After the appliance is scrapped, please hand it over to a qualified professional recycling company or organization for disposal. It should not be discarded at will, so as to avoid harm to the environment. ☆ To prevent damage caused by freezing, please take measures to keep warm. If the room temperature is below 0°C, it is recommended to drain the water in the product to prevent internal frost cracking. ☆ The plug should be installed in place, and the plug pin cannot be exposed to air. ☆ Product installation and use should be away from heat and fire sources

SAVE THESE INSTRUCTIONS

1.List of materials

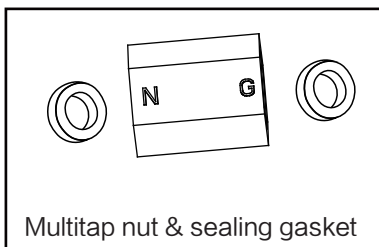
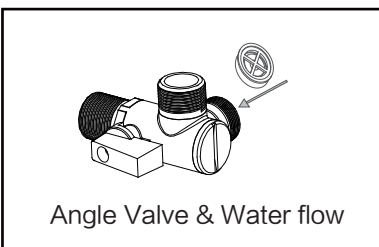
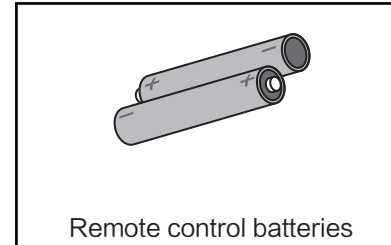
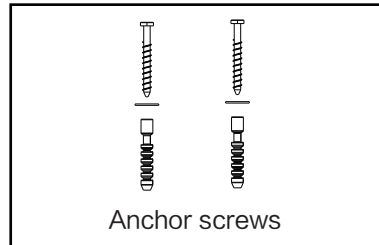
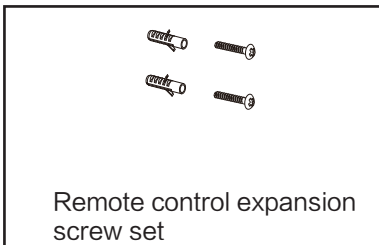
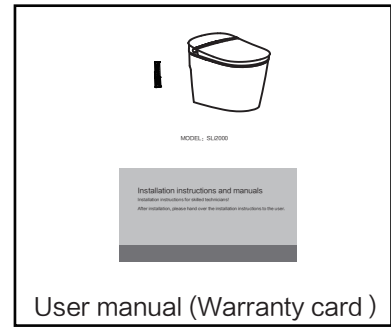
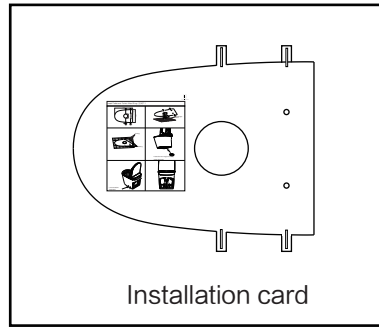
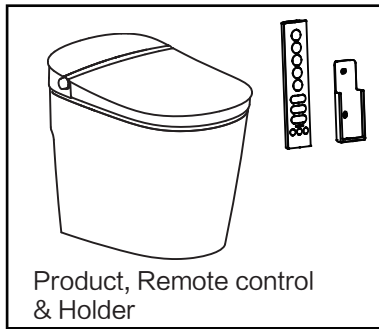

PIC for reference only

2.Technical specifications

Cleansing	Rear washing	●	Night light	●
	Front washing	●	Remote controller	●
	Auto washing	●	Rated voltage	120V~
	Oscillating	●	Rated frequency	60Hz
	Water pressure adj.	5 level	Rated power	1000W
	Water temp. adj.	3 level+Room temp.	Anbinate temp.	0°C~40°C
	Nozzle position adj.	5 level	Pressure of Water supply	30psi~80psi(Static pressure)
Fresh air	Warm air	●	Flow of Water supply	≥25L/min
	Air temp. adj.	3 level+Room temp.	Temp of Water supply	3°C~35°C
Seat and Cover	Seat temp. adj.	3 level	Water proof rate	IPX4
	Soft close	●	Water temp.	Water supply temp. ~41°C
	Seat sensor	●	Water heating power	1000W
Cleansing	Antibacterial nozzle	●	Seat temp.	Room temp.~41°C
	Nozzle self cleansing	●	Seat heater power	60W
	Nozzle manual cleansing	●	Ordinary dry temp	Room temp.~60°C
Flush	Dual flush	●	Maximum wind speed	≥4m/s
	Auto flush	●	Steam Air heater power	250W
	Pre-wetting	●	Product size	701X441(425)X480mm

Note: Rated power is the average power that under the conditions of ambient temperature of 23°C ± 2°C, inlet static pressure of 30psi ± 2psi, inlet water temperature of 5°C ± 0.5°C, turn on the rear wash function and set the water flow, seat temperature and water temperature to the highest level successively, and press Stop button then start rear wash function immediately and continue to work steadily for one cleaning cycle.

3. Installation

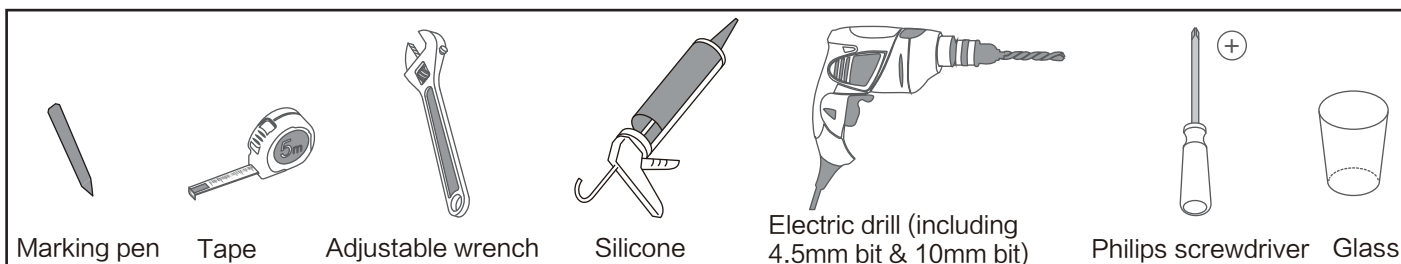

3.1 Install the Adapter Nut, Angle Stop

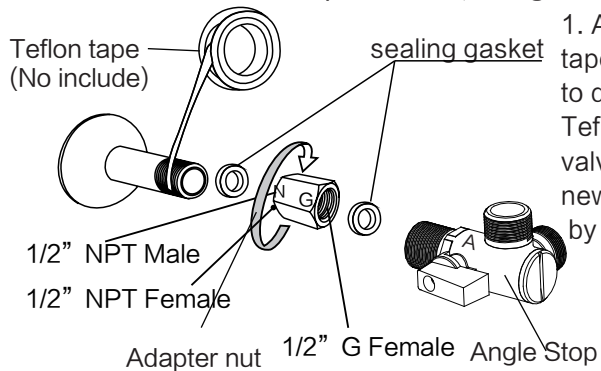

1. After external thread of water outlet pipe is wrapped with Teflon tape, adapter nut need install sealing gasket, tighten the adapter nut to direction N, then after external thread of angle stop is wrapped with Teflon tape, and tighten the connecting nut to direction G. If the angle valve has been installed on the wall, to ensure proper installation of new angle stop, the angle valve shall be replaced with the angle stop by professional personnel.

Installed adapter nut and angle stop

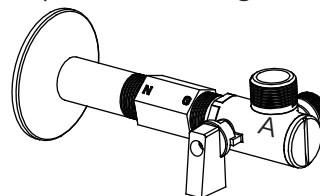

3.2 Install Toilet and Toilet Wax Ring

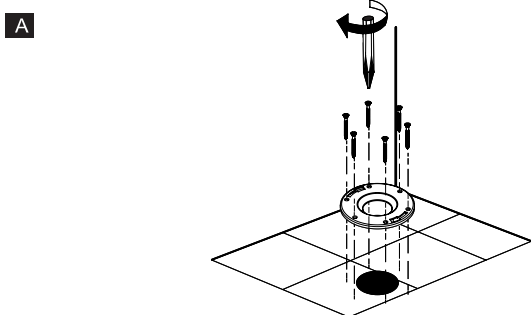

Install the floor drain cover connector (no include).

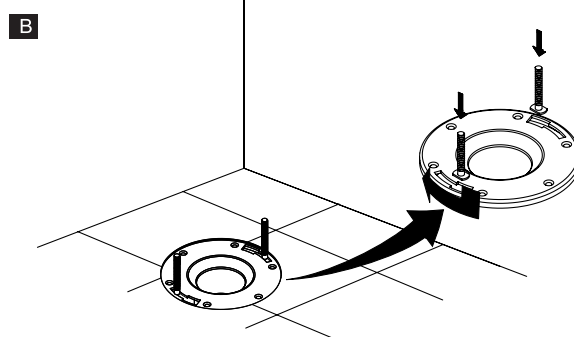

Position correctly the two fixing bolts of the floor drain.

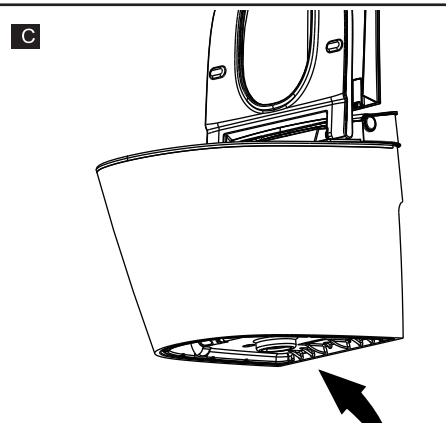

Insert the wax ring (no include) under the toilet.

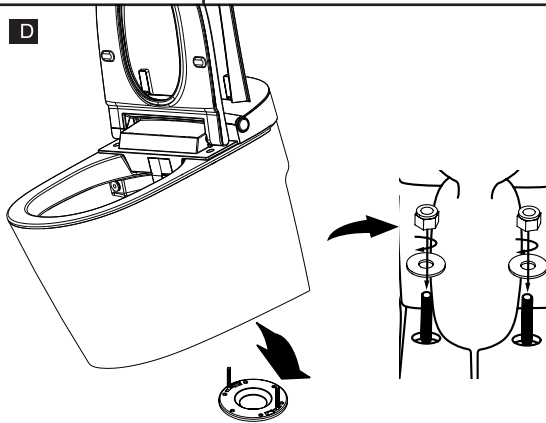

Position the toilet on the floor drain, making sure the fixing bolts are aligned with the toilet's holes.

Handing manner

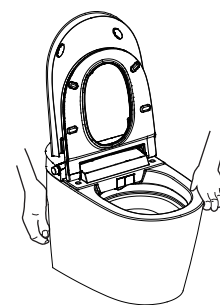

Firstly, open the cover and seat; as the toilet is heavy, lifting the product by two persons at the same time is needed.

3.3 Install the Water Supply Hose

As shown in the figure, install water supply line to angle stop.

- 1) If the water inlet pressure is greater than 30psi, please install the flow limiting plate in the angle stop;
- 2) Only use the accessory parts that are shipped with the product for installation;
- 3) After installation, check water seal and turn on the power supply. Water leakage shall be avoided.

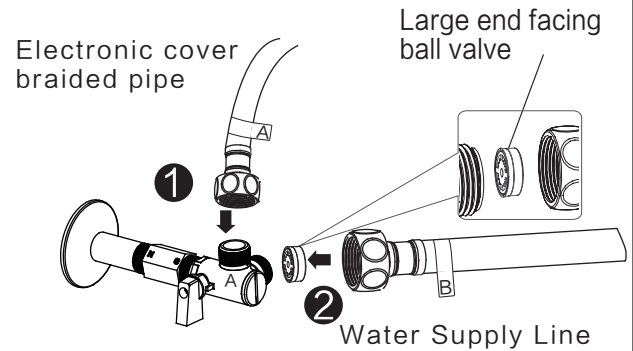

3.4 Tips for comfortable use

Spots are easily found at the lower part of the product after long time of water or urine penetration. To avoid this, silicone is recommended to paste around the lower part to seal the tiny gap between the lower part and the ground.

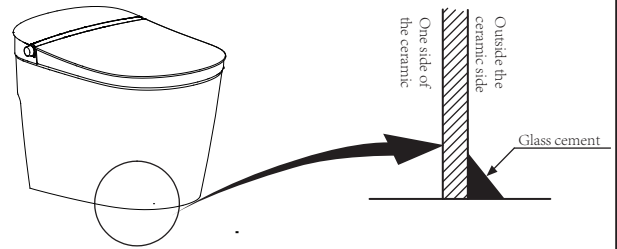

3.5 Install the Remote

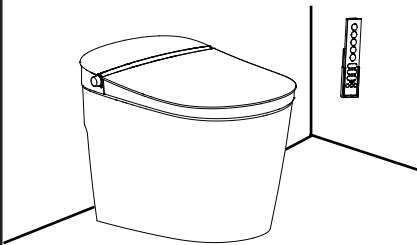

Recommended installation position of remote control

Install the remote control battery

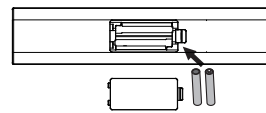

※ Used up batteries should be thrown into corresponding type of garbage cans

Installation Method 1:

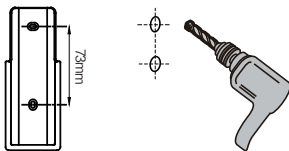

Drill two holes with a diameter of 4.5mm in the wall according to the position of holes on the remote control holder

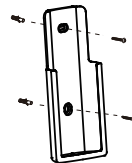

Secure the remote control holder with expansion screws.

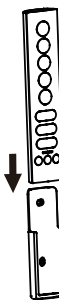

Insert the remote control into holder

Installation Method 2:

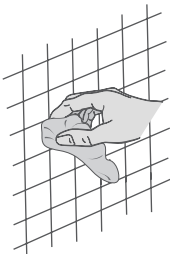

Wipe clean the walls

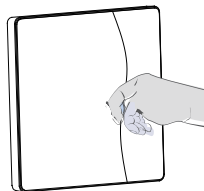

Tear the paper of double sided tape on the remote control holder

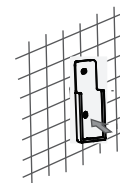

Press for a moment to ensure the double sided tape sticks with the tiles tight.

Open the angle stop



Connecting remote control

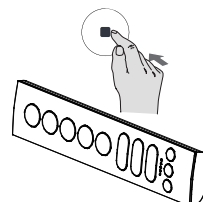

Power on

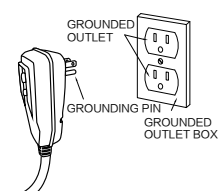

Connecting Remote Control

Long press the remote control stop key, the first, third and fifth LED lights start flickering indicating the remote control connection is ready. Then release the remote control stop key and power on the smart toilet cover. If the connection succeeds, the five LED lights on remote control will be on for 3 seconds then go off; if it fails, the first, third and fifth LED lights will flash for 30 seconds then automatically go off. If you want to quit the process of connecting, please exit by pressing the stop key.

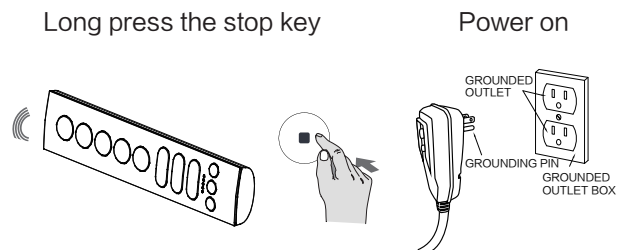

Leakage protection test

Test frequency of 1–4 points below (once a month)

1. Under normal condition, press the "reset" button on the power plug, the plug indicator light will be on and the product will start to power on;
2. Normal working condition: under rated voltage condition, the product will enter normal working state after the completion of the self-checking procedure of water and electricity.
3. Press the "Test" button, when the leakage protection is normal, the indicator light is turned off and the power is turned off;
4. Press the "Reset" button on the power plug again. The indicator light will be on and the power supply is restored.

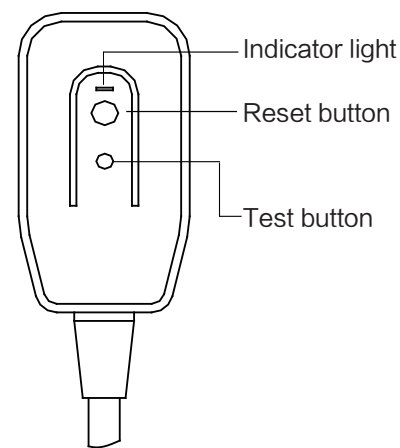

WARNING

1. Check if any leakage occurs when the power switch does not work properly.
2. The leakage protection plug only protects the product connected to the power supply through the plug. When using other electrical appliances, the product does not guarantee the leakage protection of other products; similarly, the product does not replace the basic safety measures of other electrical appliances.
3. Do not ground the live wire directly, test the leakage protection function of the product plug.

Functional Test

Press the "Seat Sensor" position with your hand, at the same time press the Rear/ Front cleansing button.

Check whether the nozzle works well.

Tip: After switching on the power, the product will do self-inspection.



4. Side button description

1. Side button operation

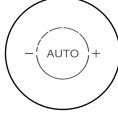
Knob definition Knob function	 Press the knob	 Rotate clockwise and counterclockwise
Automatic rear cleansing	When sitting, press knob to start automatic rear cleansing function. 15 seconds of rear cleaning at fixed position>30 seconds of oscillate cleaning>rear cleaning at fixed position then stop (From start m pressing knob to stop spraying will take about 60 seconds), and the wand automatic retract >120 seconds of dry. Press "stop" to end the cycle at any time.	
Automatic front cleansing	When sitting, long press knob for 3 seconds to start automatic front cleaning function. 15 seconds of front cleaning at fixed position>30 seconds of oscillate cleaning>front cleaning at fixed position then stop (From start m pressing knob to stop spraying will take about 60 seconds), and the wand automatic retract >120 seconds of dry. press "stop " button to end the cycle at any time.	
Flush function	Press the knob to start flush function when the toilet is unseated.	
Water pressure	During the cleaning phase, turn the knob clockwise to increase the water pressure. The toilet will beep once for each level of pressure and beep twice when the max pressure is reached. Turn the knob counter clockwise to decrease the pressure. The same sound alerts will apply when decreasing the pressure.	
Wind temperature	During the drying phase, turn the knob clockwise to increase the dyer temperature. The toilet will beep once for each level of temperature and beep twice when the max temperature is reached. Turn the knob counter clockwise to decrease the temperature. The same sound alerts will apply when decreasing the temperature.	
Stop function	When working (rear cleansing, front cleansing, warm air drying), press the knob and execute the stop command.	
Standby mode:	While leaving seat, long press the knob for 10 seconds will enter to standby mode. Press any button on remote control or on seat will bring the bidet out of standby mode.	

2. Button operations

In the non-cleansing state, press the  button to use the flushing function.

3.Side indicator light

When the whole machine is in power-off or standby state,there is no indicator light display.

When the whole machine is in the sitting/working state,the side button indicator display blue.

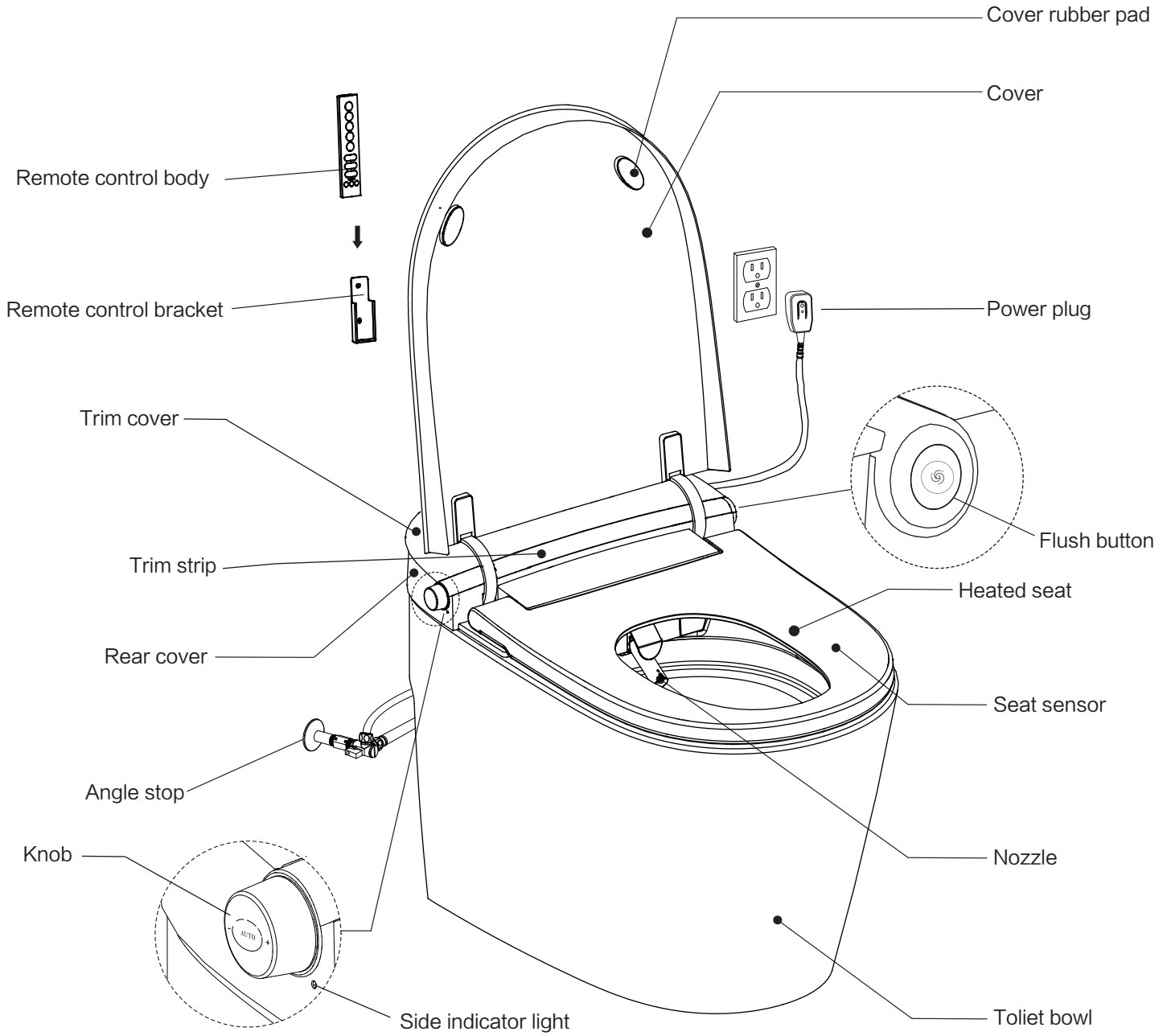

5.Part identification

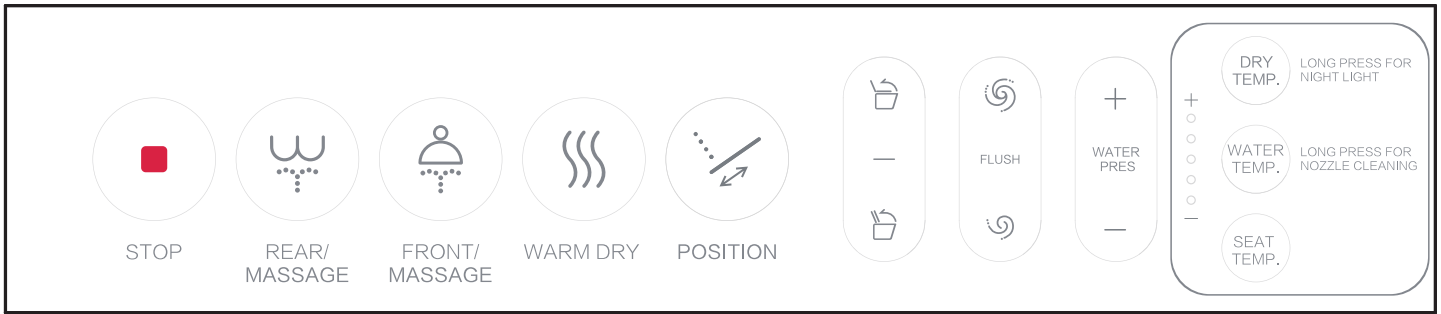

6.Remote control instructions



● Rear cleansing/Front cleansing

When sitting, press  button or  button, enter the rear cleansing or front cleansing mode, press the button again to enter the wide strong cleansing or oscillate cleansing mode for continuous cleansing which stops automatically after 3 minutes or after leaving the seat; or press  button to stop the cleansing function.

● Water Temperature Setting

Press  to adjust water temperature between 3 different levels. Press once to raise one level. Once the highest level is reached, each press will decrease by one level. The indicator light will display accordingly.

● Water Pressure Setting (In the cleansing mode)

While in the cleaning mode, Press  to adjust water pressure between 5 different levels. Press once to raise one level. Once the highest level is reached, each press will decrease by one level. The indicator light will display accordingly.

● Stop function

When working (rear cleansing, front cleansing, warm air drying), press  and execute the stop command.



● Nozzle automatic cleaning mode

In off-seat state, long press  button, the nozzle extends out for automatic cleaning for about 2 minutes and then retracts. Press button, stop the nozzle self-cleaning.

● Seat temperature setting

Press  button to adjust seat temperature between 3 different levels. Press once to raise one level. Once the highest level is reached, press again to lower one level. The indicator light will display accordingly.

● Warm air setting

When sitting on seat, press  to activate drying function. It will stop when (1) you press  button (2) about 5min later (3) stops at any time when users leaves the seat. Press  to adjust drying temperature between 3 different levels. Press once to raise one level. Once the highest level is reached, press again to lower one level. When drying function is off, press again to raise one level. The indicator light will display accordingly.

● Nozzle position adjustment

Press  button to adjust the wand between five different position. Press once to move up one level. Once the highest level is reached, press again to move back one level. The indicator light will display accordingly.



● Burn Protection

After sitting for 180 seconds, the control system automatically lowers the temperature to prevent people from being scalded by high temperature.

● Night Light Setting

Long press  button, the night light will switch between turning on the night light and turning off the night light mode.

● Flush function setting

Short press  /  to turn on large volume flush/ small volume flush function. After sitting for more than 3 seconds the toilet will sense the user. Then the toilet will auto flush approximately 6 seconds after leaving the seat.

● Pre-wetting

When sitting on the seat, the automatic ceramic washing function turns on. (Pre-wetting mode is flushing the ceramic once. And each time return to seat to achieve the function should be with more than 20 seconds interval)

● Automatic deodorization

After the user is on seat, the deodorizing function will start automatically, Once the user leaves the seat, the function will turn off after 20 seconds.

● Warm tips

If it is not used for more than 72 hours, it will automatically turn on self-cleaning for 30 seconds for water change when sitting again.

● Cover opening and closing

Press  button to open or close the cover; press  button to open or close the seat;

Warning

If the drainage pipe is blocked, stop water drainage. Find professional personnel to dredge the pipe, otherwise water may flow out of the ceramic.

7. cleansing filter screen

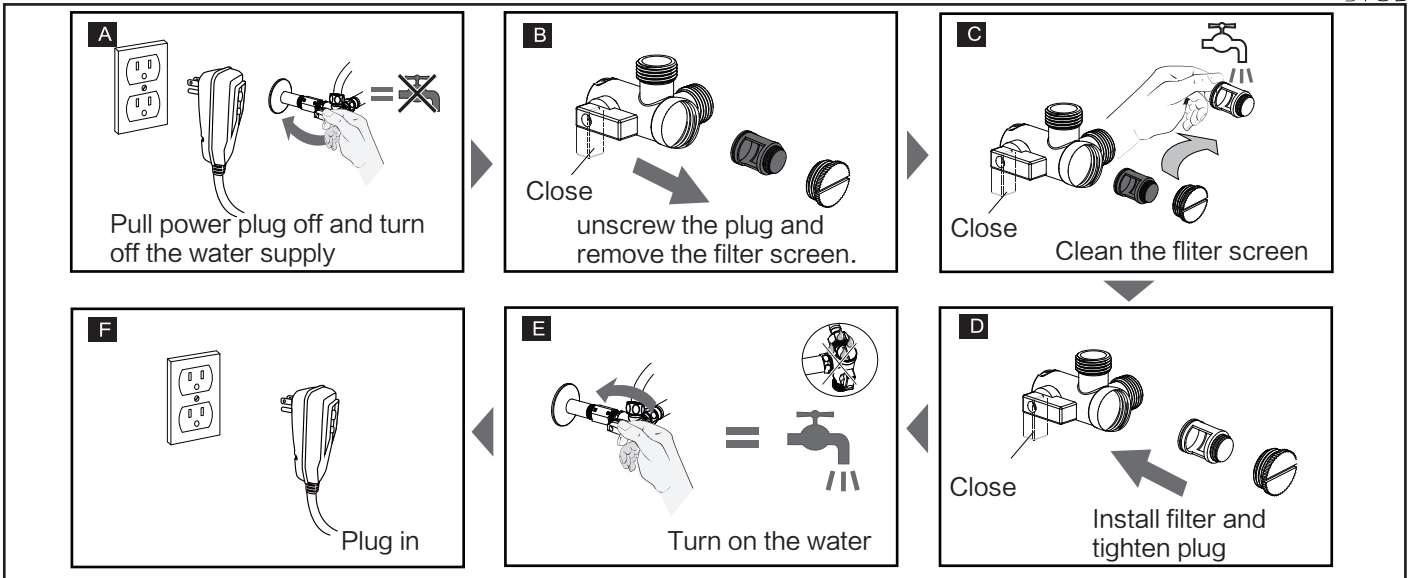

8. Nozzle cleansing

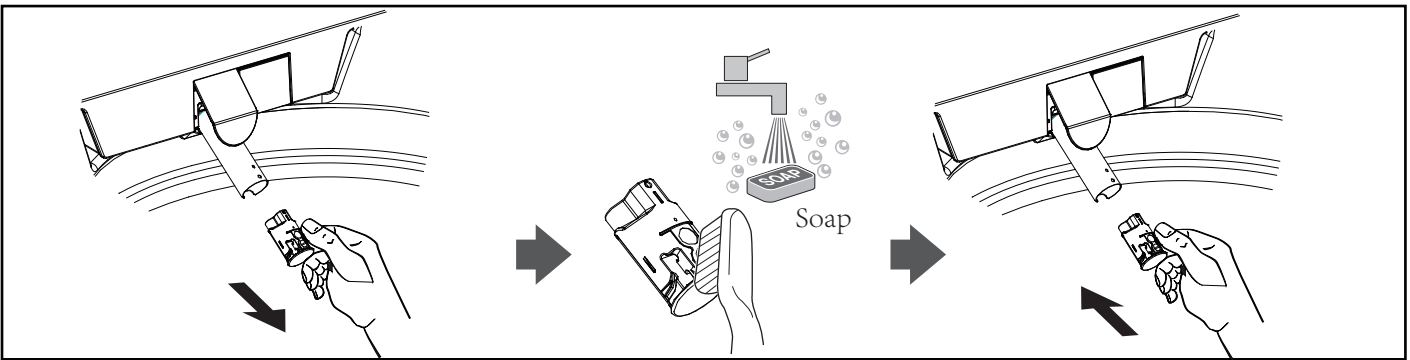

9. Removal and installation of E-bidet

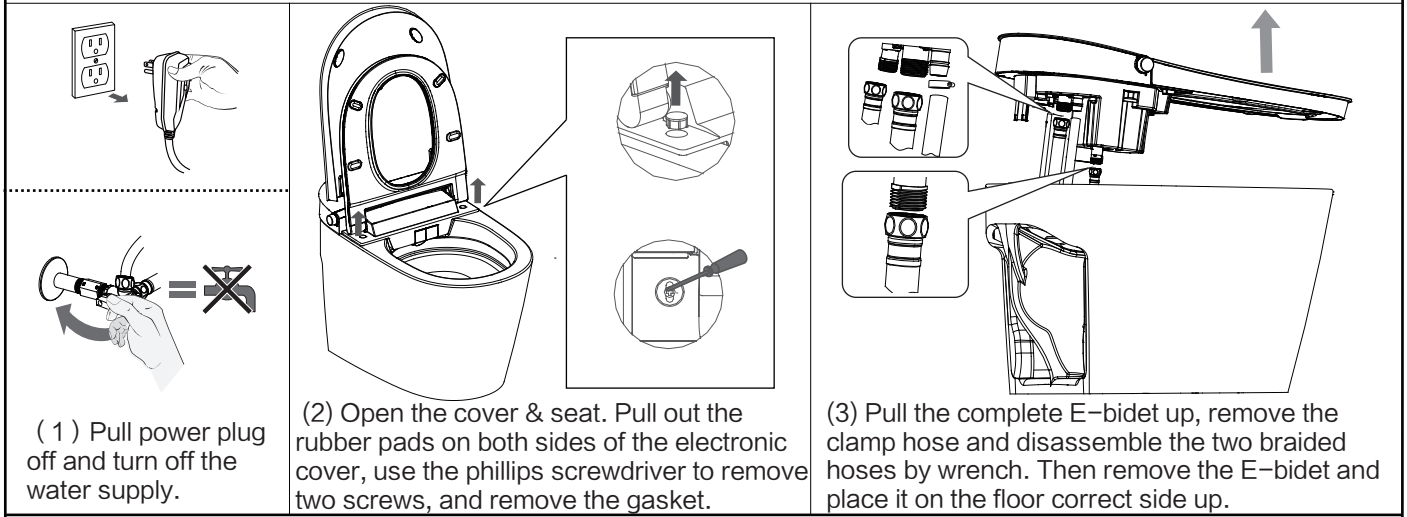

E-bidet removal

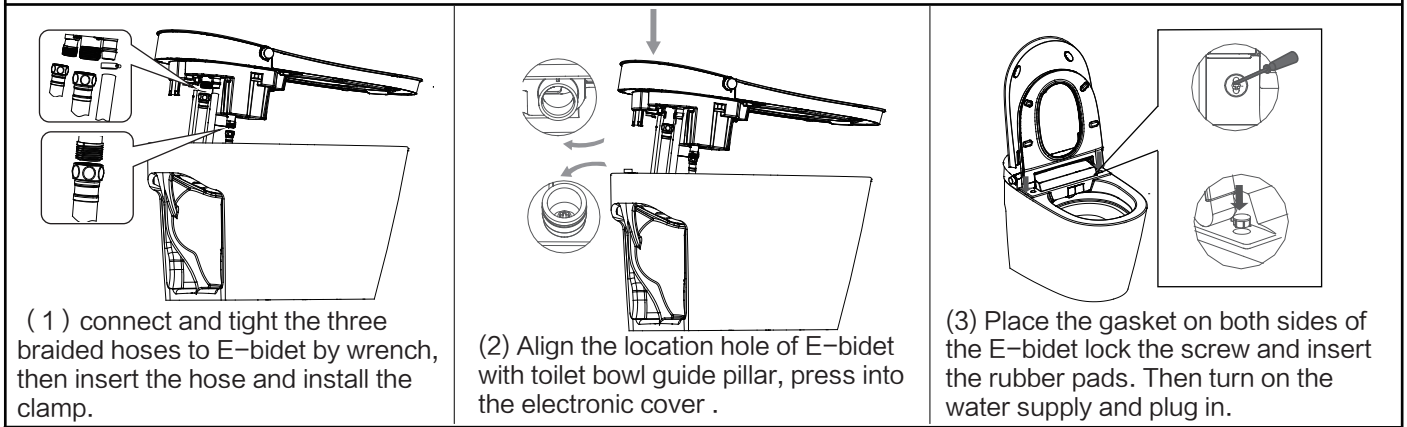

E-bidet installation

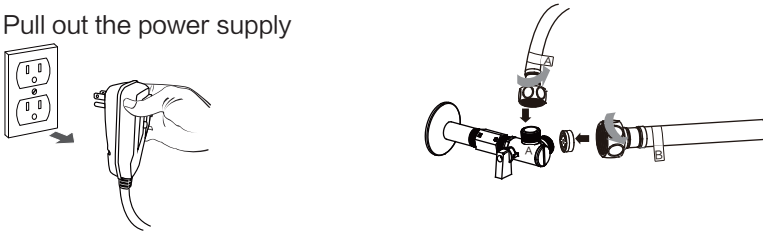

10. Long time non-use processing mode

<p>Step1: Turn off the stop valve, When leave from the seat, long press  button to enter self cleansing mode. Move to step2 after self cleansing completed.</p>  <p>Turn off water supply</p> <p>Close</p>	<p>Step 2: Pull the plug out, loosen the braided pipe, drain out the inside water.</p> <p>Pull out the power supply</p> 
--	--

11. Cleaning and maintenance

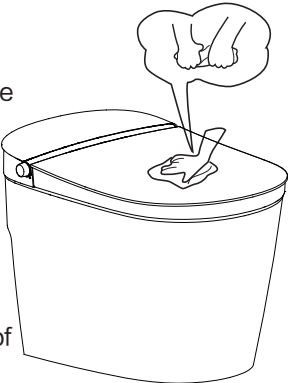
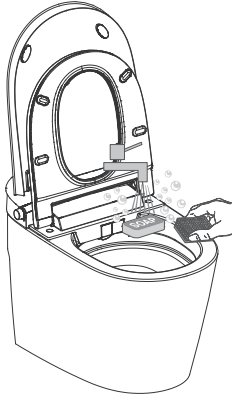
<p>Cleaning the Cover & Seat: Turn off the water supply, pull out the power plug. Use a soft and wet cloth to clean the product (Wring out a cloth)</p> <p>Notices: Do not use dry cloth or toilet paper to clean the product or the appearance of product will be scratched. Avoid putting water into the inside of back cover, otherwise some electronic components in the back cover might be damaged.</p> 	<p>Cleaning the toilet bowl: Notices: Clean the toilet bowl with cleaner and flush the cleaner within 3 minutes.</p> 
--	---

Maintenance record

Date of maintain	Maintenance items	Maintenance company	Maintenance personnel signature

There may be differences between the contents of this manual and the real object. Please refer to the real object. If the products and attachments have any update, we will not notice.

Warranty card

Product model	
Manufacturing number	
Customer name	
Tel	
Add	
Sales company	
Tel	
Date of purchase	

The 2nd copy send back

Issue		Cause	Solution
Heated Seat	Seat temperature is not warm enough during usage.	Is seat temperature set to “off” or on the lowest setting?	Reset the seat temperature to a higher setting.
	Seat temperature is too hot	Is seat temperature set on the highest setting?	Reset the seat temperature to a lower setting.
Night light function	Night Light Off	Night light is set on “off” status.	Press the “Night Light” button to turn on the light.
	Night Light on	Night light is set on “on” status.	press the “Night Light” button to turn off the light.
Nozzle cleansing	Nozzle moves back automatically	Nozzle will move back automatically after 2 mins from starting nozzle self-cleaning mode.	This is normal phenomenon.
	Nozzle does not extend after pressing the “nozzle clean” button.	Electro conductive material such as water drops or wet paper will trigger seat sensor.	Remove conductive media from the seat.
Flush function	Press the flush button of remote control, the product can't flush automatically.	Is the water supply and power are cut off or not?	Turn on water supply and power supply recovery.
	There is noise during flushing.	No Water supply or the water pressure is very low.	This is normal phenomenon.
		Is the filter screen dirty?	Clean the filter screen
Drying	Drying temperature is not warm enough.	Is drying temperature set to “off” or on the lowest setting?	Reset the drying temperature on a higher setting.
	Drying stops suddenly.	If the user leaves the seat suddenly, the sensor may not be able to find the correct position of user.	Sit on the seat sensor again and press the drying button.
	Drying function does not work.	Is the seat sensor being contacted?	Sit on the seat sensor again and press drying button.
		Did you select any cleansing function?	Turn off the cleansing functions and press the drying button.

12.Troubleshooting

Frequently asked questions. (FAQ)

Please read the following questions carefully, and refer to the instructions. If the product still does not work contact your local sales dealer or contact the manufacturer.

Tips:

If there is water leakage, immediately turn off the water supply and pull the power plug.

The following reasons may cause product's malfunction.

1.Check the power supply

- (1) Is power supply working properly?
- (2) Is the Plug plugged in?
- (3) Is electricity-leakage protection switch off?

2.Check the water supply

- (1) Is water supply working properly?
- (2) Is the Water Supply off?
- (3) Is the PSI lower than 30?

Once any of the following issue occur,please cut the power off immediately.Refer to the affected section in this manual. Please contact the manufacturer for more assistance if necessary.

1.Power leakage protection switch on power plug trips frequently.

Issue		Cause	Solution
Product not working		Is power supply turned off?	Power on
Remote controller	Remote controller doesn't work	Did the battery run out?	Replace with new batteries.
		Do the positive and negative pole of the battery set correctly?	Reset the batteries in the correct direction.
	The button of remote controller is insensitive	Low battery?	Replace with new batteries
		Is the remote control too far away from the product or not within the sensor range of the remote	Please use the remote control within the effective sensor range.
Rear cleansing /Front cleansing	Nozzle extends too slowly	When activating the front or rear cleansing function, the nozzle will move back for self-cleaning, then moves out for cleansing. This operation will take several seconds.	This is normal phenomenon
	Lower water pressure	Is the setting too low?	Reset the water flow to a higher setting on the remote control.
		Is the filter screen dirty?	Clean or replace the filter screen.
		Is the connection nut of water supply hose loosen? Does water leak from the hose?	Lock the nuts tightly.
	Lower water temperature	Is the water temperature set on "low" or "off" status?	Reset the water temperature to "high" or "on" status by the remote control.
Nozzle stops to spray water suddenly	After 3 minutes of cleaning, the nozzle will automatically stop spraying and retract.	This is normal phenomenon.	
	If the user moves too quickly or move away from the seat, the sensor may not be able to find the position of user in a short time.	Return to the sensor detection position on the seat ring and activate the front or rear cleaning function.	